



Operation Manual

Smart-UPS[®]

Uninterruptible Power Supply

**750/1000/1500/2200/3000 VA Tower
100/120/230 Vac**

**500 VA Tower
100 Vac**

Overview

Product Description

The APC® by Schneider Electric Smart-UPS® 500 VA to 3000 VA Tower is a high performance uninterruptible power supply (UPS). It provides protection for electronic equipment from utility power blackouts, brownouts, sags, and surges, small utility fluctuations and large disturbances. The UPS also provides battery backup power for connected equipment until utility power returns to safe levels or the batteries are fully discharged.

Safety and General Information

Read the Safety Guide included in the package before installing the UPS.

This unit is intended for indoor use only.

Do not operate this unit in direct sunlight, in contact with fluids, or where there is excessive dust or humidity.

Be sure the air vents on the UPS are not blocked. Allow adequate space for proper ventilation.

The battery typically lasts for two to five years. Environmental factors impact battery life. Elevated ambient temperatures, poor quality utility power, and frequent short duration discharges will shorten battery life.

Connect the Smart-UPS power cable directly to a wall outlet. Do not use surge protectors or extension cords.

The batteries are heavy. Remove the batteries prior to installing the UPS in a rack.

Specifications

For additional specifications, refer to the APC Web site at www.apc.com.

Environmental

Temperature	Operating	0° to 40° C (32° to 104° F)
	Storage	-15° to 45° C (5° to 113° F) charge UPS battery every six months
Maximum Elevation	Operating	3,000 m (10,000 ft)
	Storage	15,000 m (50,000 ft)
Humidity	0% to 95% relative humidity, non-condensing	

Product Overview

Front panel features

- ❶ Display interface
- ❷ Bezel
- ❸ Battery
- ❹ Internal battery connector

500/750/1000/1500 VA

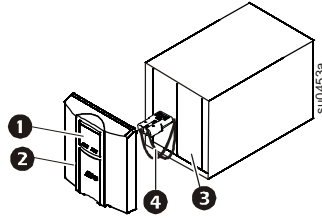

2200/3000 VA

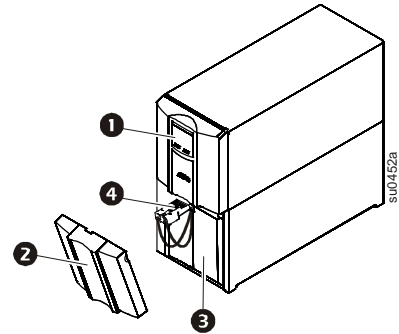

Rear panel features 500 VA to 1500 VA models

- ❶ USB port
- ❷ Serial port
- ❸ Ground screw
- ❹ Smart slot
- ❺ Circuit breaker
- ❻ UPS input
- ❼ Outlets
- ❽ Internal or external battery connector

500/750 VA 100 Vac
750 VA 120 Vac

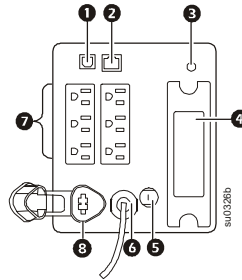

750 VA 230 Vac

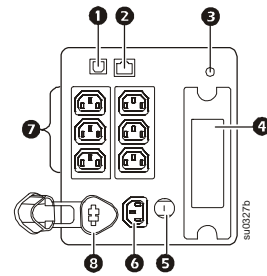

1000 VA 100 Vac
1000/1500 VA 120 Vac

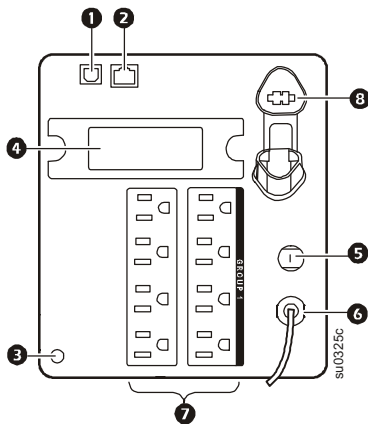

1500 VA 100 Vac

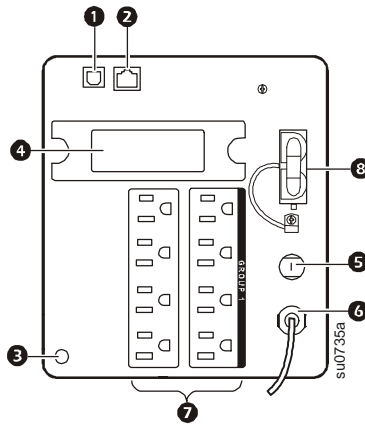

1000/1500 VA 230 Vac

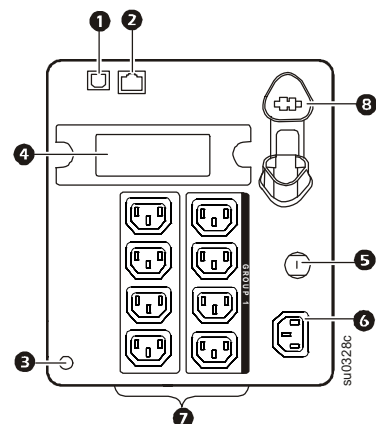

Rear panel features 2200 VA and 3000 VA models

- ❶ USB Port
- ❷ Serial port
- ❸ Ground screw
- ❹ SmartSlot
- ❺ Circuit breaker
- ❻ UPS input
- ❼ Outlets
- ❽ EPO connector

2200 VA 120 Vac

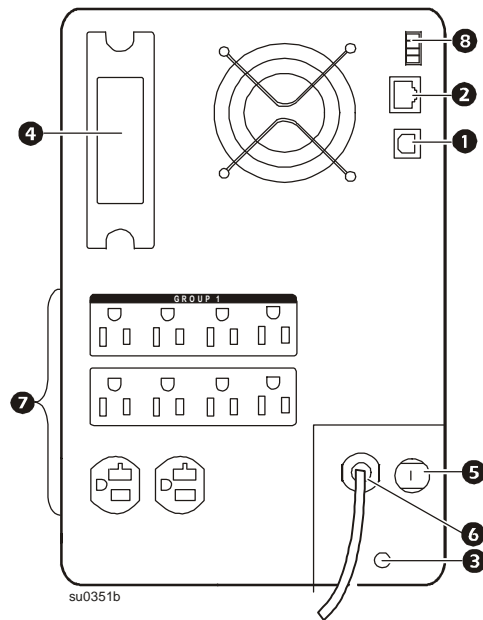

2200/3000 VA 100 Vac
3000 VA 120 Vac

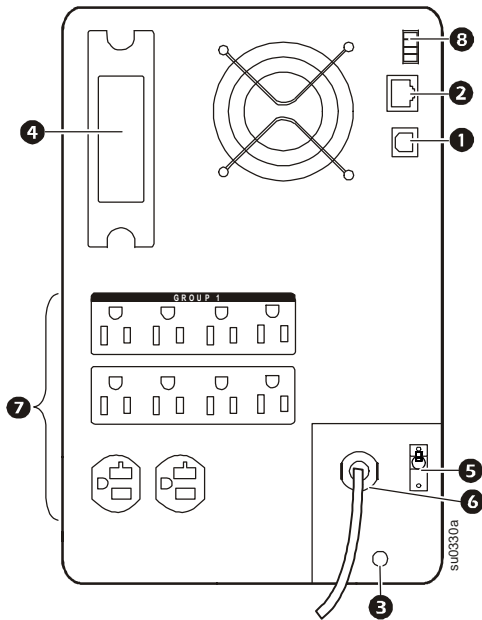

2200/3000 VA 230 Vac

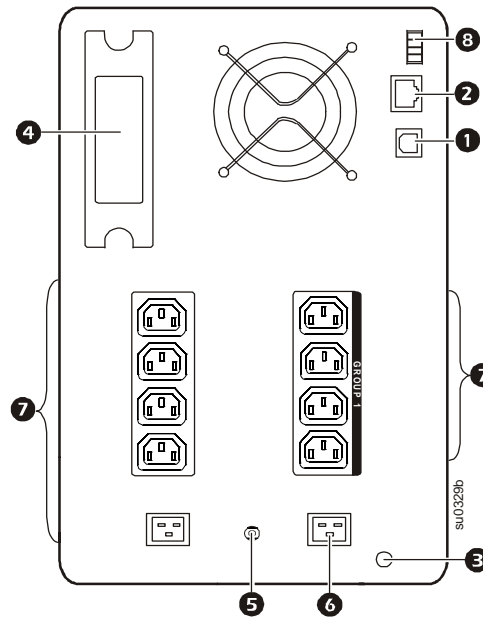

Installation

For UPS installation information, refer to the Smart-UPS Installation Guide 750/1000/1500/2200/3000 VA 100/120/230 Vac, 500 VA 100 Vac Tower, that is included with the UPS. The Installation guide is also available on the documentation CD included with the UPS and on the APC Web site, www.apc.com.

Operation

Connect Equipment



Note: The UPS will charge to 90% capacity in the first four and a half hours of normal operation *for the 2200/3000 VA 100 Vac model* or the first three hours of normal operation *for all other models*. **Do not expect full battery runtime capability during this initial charge period.**

1. Connect equipment to the UPS.
2. Connect the UPS to the building utility power. **Connect the UPS to a two-pole, three-wire, grounded source only.**
3. To use the UPS as a MASTER ON/OFF switch, turn on equipment that is connected to the UPS.

See “Main Outlet Group and Switched Outlet Group” on page 9 for information on how to configure the outlet groups.

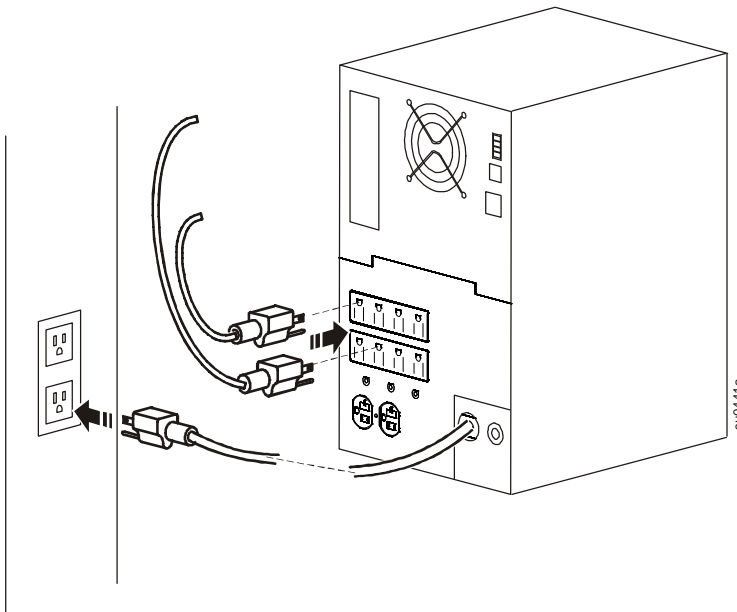

Rear Panel Features



Serial port: Connect to a computer to use power management software.



USB port: Connect to a computer to use power management software.



Ground Screw: Connect the ground leads on transient voltage devices to the chassis ground screw(s), located on the rear panel of the UPS.

Display Panel

- ❶ Online LED
- ❷ On Battery LED
- ❸ UPS Output ON/OFF key
- ❹ Fault LED
- ❺ Replace Battery LED
- ❻ Display screen
- ❼ UP and DOWN keys
- ❽ ENTER key
- ❾ ESCAPE key

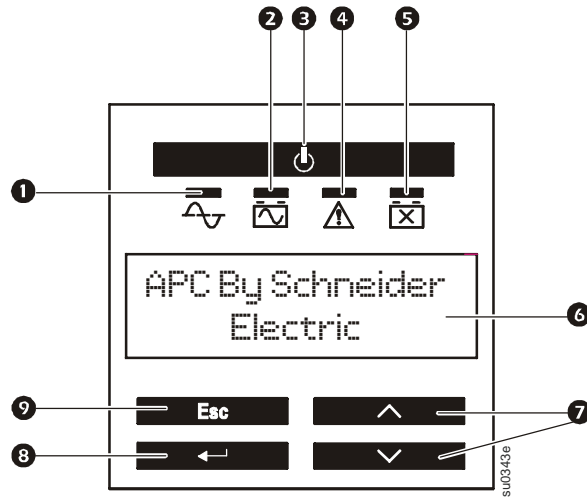

Using the display interface

Use the UP and DOWN keys to scroll through the main menu options. Press ENTER to view the sub-menus under each main menu option. Press ESCAPE to exit a sub-menu and return to a main menu.

Standard menus

The Standard menus are the most commonly used menus.

Menu	General Functions
Status	View UPS information: <ul style="list-style-type: none"> • Operating Mode • Efficiency • Load Power • Load VA • Battery Charge state • Estimated Runtime • Battery Temp • Input • Output • Last Transfer • Last UPS Self Test
Configuration	Configure UPS settings: <ul style="list-style-type: none"> • Language • Local Power Quality: Good, Fair, Poor • Menu Type: Standard or Advanced • Audible Alarm • Display (Auto Dim, Auto Off, Always On) • Battery Install Date • Reset to Factory Default
Test & Diags	Perform UPS tests and diagnostic functions: <ul style="list-style-type: none"> • UPS Self Test • UPS Alarms Test • Calibration Test
About	View UPS information: <ul style="list-style-type: none"> • UPS Model • UPS Part No. • UPS Serial No. • UPS Manufacture Date • Battery Part No. • Battery Install Date • Replace Battery by • UPS Firmware 1

Advanced menus

The Advanced menus provide additional options for the UPS and are available only if the display interface is configured to use the Advanced menus.

Menu	General Functions
Status	View detailed UPS information: <ul style="list-style-type: none"> • Operating Mode • Efficiency • Load Power • Load VA • Load Amps • Load Energy • Battery Charge state • Estimated Runtime • Battery Voltage • Battery Temp • Input • Output • Last Transfer • Last UPS Self Test • Outlet Group 1 (if Switched Outlet is available) • NMC IP Address (if NMC is available)
Configuration	Configure advanced UPS settings: <ul style="list-style-type: none"> • Language • Local Power Quality • Menu Type • Audible Alarm • Display (Auto Dim, Auto Off, Always On) • Sensitivity • Low Transfer • High Transfer • Low Battery Warning • Auto Self Test • Battery Install Date • Reset Energy Meter • Enter Setup Wizard • Firmware Update (standby mode) • Reset to Factory Default • Config Main Group Outlets • Config Group 1 Outlets (if Switched Outlet is available) • Config NMC (if NMC is available)
Control	Control the Main and Switched Outlet Group to turn on, turn off, shutdown, or reboot.
Test & Diags	Perform UPS test and diagnostic functions: <ul style="list-style-type: none"> • UPS Self Test • UPS Alarms Test • Calibration Test
Log	View the event and error logs for information about UPS events and faults that have occurred.
About	View UPS information: <ul style="list-style-type: none"> • UPS Model • UPS Part No. • UPS Serial No. • UPS Manufacture Date • Battery Part No. • Battery Install Date • Replace Battery by • UPS Firmware 1 • UPS Firmware 2 • UPS Firmware 3 • UPS Firmware 4 • NMC Model No.* • NMC Serial No.* • NMC Hardware Version* • NMC Manufacture Date* • NMC MAC Address* • SmartSlot FW 1* • SmartSlot FW 2* • SmartSlot FW 3* <p style="text-align: right;">*If NMC is available</p>

Configuration

UPS Settings

Start-up Settings

Configure these settings at initial start-up, using the display interface. As an alternative, configuration can be performed using APC PowerChute® software.



Note: During start-up, use the display interface to configure these settings. If nothing is selected, the unit will use the default settings.

Function	Factory Default	Options	Description
Language	English	<ul style="list-style-type: none"> • English • French* • German* • Spanish* • Italian* • Portuguese* • Japanese* 	<p>The language for the display interface.</p> <p>*Language options will vary by model.</p>
Local Power Quality	Good	<ul style="list-style-type: none"> • Good • Fair • Poor 	<p>Select the quality of input utility power.</p> <ul style="list-style-type: none"> • If Good is selected, the unit will go on battery power more often to provide the cleanest power supply to the connected equipment. • If Poor is selected, the UPS will tolerate more fluctuations in power and will go on battery power less often. <p>If unsure of the local power quality, select Good.</p>
Menu Type	Standard	Standard or Advanced	The Standard menus display a limited set of menus and options. The advanced menus include all parameters.

General Settings

Configure these settings at any time. Use the display interface or APC PowerChute® software.

Function	Factory Default	Options	Description
High Transfer Point	100 Vac: 108 Vac	<ul style="list-style-type: none"> • 108 Vac • 110 Vac • 112 Vac • 114 Vac 	<p>To avoid unnecessary battery usage, set the transfer point higher if the utility voltage is chronically high and the connected equipment is known to work under this condition. The Power Quality setting will automatically change this setting.</p> <p>Note: Use the Advanced Menus to configure this setting.</p>
	120 Vac: 127 Vac	<ul style="list-style-type: none"> • 127 Vac • 130 Vac • 133 Vac • 136 Vac 	
	230 Vac: 253 Vac	<ul style="list-style-type: none"> • 253 Vac • 257 Vac • 261 Vac • 265 Vac 	

Function	Factory Default	Options	Description
Low Transfer Point	100 Vac: 92 Vac	<ul style="list-style-type: none"> • 86 Vac • 88 Vac • 90 Vac • 92 Vac 	Set the transfer point lower if the utility voltage is chronically low and the connected equipment can tolerate this condition. This setting may also be adjusted using the power quality setting. Note: Use the Advanced Menus to configure this setting.
	120 Vac: 106 Vac	<ul style="list-style-type: none"> • 97 Vac • 100 Vac • 103 Vac • 106 Vac 	
	230 Vac: 208 Vac	<ul style="list-style-type: none"> • 196 Vac • 200 Vac • 204 Vac • 208 Vac 	
Nominal Output Voltage	100 Vac	N/A	230 Vac models only: Set the nominal output voltage of the UPS to standby mode.
	120 Vac	N/A	
	230 Vac	<ul style="list-style-type: none"> • 220 Vac • 230 Vac • 240 Vac 	
Transfer Sensitivity	Normal	Normal, Reduced, Low	Select the level of sensitivity to power events that the UPS will tolerate. <ul style="list-style-type: none"> • Normal: The UPS will go on battery power more often to provide the cleanest power supply to the connected equipment. • Low: The UPS will tolerate more fluctuations in power and will go on battery power less often. If the connected load is sensitive to power disturbances, set the sensitivity to High.
Low Battery Warning	120 sec	Set the value in seconds	The UPS will emit an audible alarm when the remaining runtime has reached this level.
Date of Last Battery Replacement	Date set at factory	Reset this date when the battery module is replaced.	
Audible Alarm	On	On/Off	The UPS will mute all audible alarms if this is set to Off or when the display keys are pressed.
Battery Self-Test Interval Setting	On start-up and every 14 days since the last test	<ul style="list-style-type: none"> • Never • Start-up only • Frequency of test (every 7 to 14 days) 	The interval at which the UPS will execute a self-test.
Reset to Factory Default	No	Yes/No	Restore the UPS factory default settings.

Main Outlet Group and Switched Outlet Group

Overview

The Main Outlet Group and the Switched Outlet Group can be configured to independently turn off, turn on, shut down, and reboot connected equipment. (These features are not available on the 500 VA or 750 VA units.)

The Main and Switched Outlet Groups can be configured to do the following:

- Turn off: Disconnect from power immediately and restart only with a manual command.
- Turn on: Connect to power immediately.
- Shutdown: Disconnect power in sequence, and automatically reapply power in sequence when utility power becomes available.
- Reboot: Shut down and restart.

In addition, the Main Outlet Group and the Switched Outlet Group can be configured to do the following:

- Turn on or off in a specified sequence
- Automatically turn off or shut down when various conditions occur

Note: If the Main and Switched Outlet Groups are not configured, all of the outlets on the unit will still provide battery back-up power.

Using the Main and Switched Outlet Groups

The Main Outlet Group functions as a master switch. It will turn on first when power is applied, and shut down last when there is a power outage and battery run-time has been exhausted.

The Main Outlet Group must be turned on for the Switched Outlet Group to turn on.

1. Connect critical equipment to the Main Outlet Group.
2. Connect peripheral equipment to the Switched Outlet Group.
 - Nonessential equipment that should shut down quickly in the event of a power outage can be added to a short power off delay, to conserve battery runtime.
 - Equipment that has dependent peripherals that must restart or shut down in a specific order should be connected to a separate outlet group.
 - Equipment that needs to reboot independently from other equipment should be added to a separate outlet group.
3. Use the **Configuration** menus to set reaction of the Switched Outlet Group in the event of a power outage.

Customize the Main and Switched Outlet Groups

Use the **Configuration** menus to change the Main Outlet Group and the Switched Outlet Group settings.

Function	Factory Default	Options	Description
Name String Outlet Group	Outlet Group 1	Edit these names using an external interface, such as the Network Management Card Web interface.	
UPS Name String	UPS Outlets		
Turn On Delay	0 sec	Set the value in seconds	The amount of time the UPS or a Switched Outlet Group will wait between receiving the command to turn on and the actual startup.
Turn Off Delay	<ul style="list-style-type: none"> • 0 sec (UPS Outlets) • 90 sec (Switched Outlet Groups) 	Set the value in seconds	The amount of time the UPS or a Switched Outlet Group will wait between receiving the command to turn off and the actual shut down.
Reboot Duration	8 sec	Set the value in seconds	The amount of time the UPS or a Switched Outlet Group must remain off before it will restart.
Minimum Return Time	0 sec	Set the value in seconds	The amount of battery runtime that must be available before the UPS or a Switched Outlet Group will turn on after a shutdown.
Load Shed On Battery	Disabled	<ul style="list-style-type: none"> • Enable • Disable 	<p>When the unit switches to battery power, the UPS will disconnect power to the Switched Outlet Group to save battery runtime.</p> <p>Configure this delay time, use the LOAD SHED TIME WHEN ON BATTERY setting.</p>
Load Shed Time when On Battery	1800 sec	Set the value in seconds	The amount of time the outlets will function on battery power before they will turn off.
Load Shed On Runtime	Disabled	<ul style="list-style-type: none"> • Enable • Disable 	<p>When the battery runtime falls below the specified value, the Switched Outlet Group will turn off.</p> <p>Configure this time using the LOAD SHED RUNTIME REMAINING setting.</p>
Load Shed On Runtime Remaining	120 sec	Set the value in seconds	When the remaining runtime reaches this level, the Switched Outlet Group will turn off.
Load Shed on Overload	Disabled	<ul style="list-style-type: none"> • Disabled • Enabled 	In the event of an overload (greater than 107% output), the Switched Outlet Group will immediately turn off to conserve power for critical loads. The Switched Outlet Group will only turn on again with a manual command.

Network Management Card Settings

These settings are available only on units that have a Network Management Card (NMC) and are set at the factory. These settings can only be modified using an external interface, such as the NMC Web interface.

- NMC IP Address Mode
- NMC IP Address
- NMC Subnet Mask
- NMC Default Gateway

Emergency Power Off

Overview

The Emergency Power Off (EPO) option, is a safety feature that will immediately disconnect all connected equipment from utility power. The UPS will immediately shut down and will not switch to battery power.

Adhere to all national and local electrical codes. Wiring must be performed by a qualified electrician.

Connect each UPS to the EPO switch. In configurations where multiple units are connected in parallel, each UPS must be connected to the EPO switch.

The UPS must be restarted for power to return to connected equipment. Press the ON/OFF key on the front panel of the UPS.

Normally open contacts

1. If the EPO switch or relay contacts are normally open, insert the wires from the switch or contacts at pins 1 and 2 of the EPO terminal block. Use 16-28 AWG wire.
2. Secure the wires by tightening the screws.

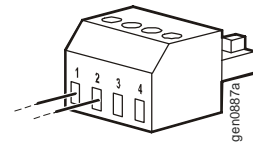

If the contacts are closed, the UPS will turn OFF and power will be removed from the load.

Normally closed contacts

1. If the EPO switch or relay contacts are normally closed, insert the wires from the switch or contacts at pins 2 and 3 of the EPO terminal block. Use 16-28 AWG wire.
2. Insert a wire jumper between pins 1 and 2. Secure the wires by tightening the three screws at positions 1, 2, and 3.

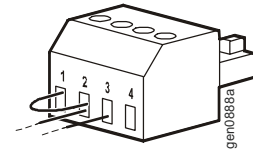

If the contacts are opened, the UPS will turn OFF and power will be removed from the load.

Note: Pin 1 is the power source for the EPO circuit, it provides a few milliamperes of 24 V power.

If the normally closed (NC) EPO configuration is used, the EPO switch or relay should be rated for “dry” circuit applications, the rating should be for low voltage and low current applications. This normally implies the contacts are gold-plated.

The EPO interface is a Safety Extra Low Voltage (SELV) circuit. Connect the EPO interface only to other SELV circuits. The EPO interface monitors circuits that have no determined voltage potential. SELV circuits are controlled by a switch or relay properly isolated from utility power. To avoid damage to the UPS, do not connect the EPO interface to any circuit other than a SELV circuit.

Use one of the following cable types to connect the UPS to the EPO switch.

- CL2: Class 2 cable for general use.
- CL2P: Plenum cable for use in ducts, plenums, and other spaces used for environmental air.
- CL2R: Riser cable for use in a vertical run in a floor-to-floor shaft.
- CLEX: Limited use cable for use in dwellings and for use in raceways.
- Installation in Canada: Use only CSA certified, type ELC, (extra-low voltage control cable).
- Installation in countries other than Canada and the USA: Use standard low voltage cable in accordance with national and local regulations.

Troubleshooting

Problem and Possible Cause	Solution
The UPS will not turn on or there is no output.	
The unit has not been turned on.	Press the ON key once to turn on the UPS.
The UPS is not connected to utility power.	Be sure the power cable is securely connected to the unit and to the utility power supply.
The input circuit breaker has tripped.	Reduce the load on the UPS. Disconnect nonessential equipment and reset the circuit breaker.
The unit shows very low or no input utility voltage.	Check the utility power supply to the UPS by plugging in a table lamp. If the light is very dim, check the utility voltage.
The battery connector plug is not securely connected.	Be sure that all battery connections are secure.
There is an internal UPS fault.	Do not attempt to use the UPS. Unplug the UPS and have it serviced immediately.
The UPS is operating on battery, while connected to input utility power.	
The input circuit breaker has tripped.	Reduce the load on the UPS. Disconnect nonessential equipment and reset the circuit breaker.
There is very high, very low, or distorted input line voltage.	Move the UPS to a different outlet on a different circuit. Test the input voltage with the utility voltage display. If acceptable to the connected equipment, reduce the UPS sensitivity.
UPS is emits a beep.	
The UPS is operating normally.	None. The UPS is protecting the connected equipment.
UPS does not provide expected backup time.	
The UPS battery is weak due to a recent power outage or is near the end of its service life.	Charge the battery. Batteries require recharging after extended outages and wear out faster when put into service often or when operated at elevated temperatures. If the battery is near the end of its service life, consider replacing the battery even if the replace battery indicator has not illuminated.
The UPS is experiencing an overload condition.	Check the UPS load display. Unplug unnecessary equipment, such as printers.
Display interface LEDs flash sequentially.	
The UPS has been shut down remotely through software or an optional accessory card.	None. The UPS will restart automatically when utility power is restored.
The Fault LED is illuminated. The UPS displays a fault message and emits a constant beeping sound.	
Internal UPS fault.	Do not attempt to use the UPS. Turn the UPS off and have it serviced immediately.
The Replace Battery LED is illuminated and the UPS beeps for one minute every five hours.	
The battery has a weak charge.	Allow the battery to recharge for at least four hours. Then, perform a self-test. If the problem persists after recharging, replace the battery.
The Replace Battery LED is flashing and the UPS beeps once every 2 seconds.	
The replacement battery is not properly connected.	Be sure that the battery connector is securely connected.
The display interface has a Site Wiring Fault message.	
Wiring faults detected include missing ground, hot-neutral, polarity reversal, and overloaded neutral circuit.	If the UPS indicates a site wiring fault, have a qualified electrician inspect the building wiring. (Applicable for 120 V units only.)

Service

If the unit requires service, do not return it to the dealer. Follow these steps:

1. Review the *Troubleshooting* section of the manual to eliminate common problems.
2. If the problem persists, contact APC Customer Support through the APC Web site, **www.apc.com**.
 - a. Note the model number and serial number and the date of purchase. The model and serial numbers are located on the rear panel of the unit and are available through the LCD display on select models.
 - b. Call APC Customer Support and a technician will attempt to solve the problem over the phone. If this is not possible, the technician will issue a Returned Material Authorization Number (RMA#).
 - c. If the unit is under warranty, the repairs are free.
 - d. Service procedures and returns may vary internationally. Refer to the APC Web site for country specific instructions.
3. Pack the unit properly to avoid damage in transit. Never use foam beads for packaging. Damage sustained in transit is not covered under warranty.
 - a. **Note: When shipping within the United States, or to the United States always DISCONNECT A UPS BATTERY before shipping in compliance with U.S. Department of Transportation (DOT) and IATA regulations.** The internal batteries may remain in the UPS.
- b. Batteries may remain connected in the XLBP during shipment. Not all units utilize XLBPs.
 4. Write the RMA# provided by Customer Support on the outside of the package.
 5. Return the unit by insured, pre-paid carrier to the address provided by Customer Support.

Transport the unit

1. Shut down and disconnect all connected equipment.
2. Disconnect the unit from utility power.
3. Disconnect all internal and external batteries (if applicable).
4. Follow the shipping instructions outlined in the *Service* section of this manual.

Smart-UPS Factory Warranty

LIMITED WARRANTY

American Power Conversion (APC) warrants its Smart-UPS (Products) to be free from defects in materials and workmanship for a period of three (3) years, excluding the batteries, which are warranted for two (2) years from date of purchase. For country specific warranty information, refer to the APC Web site at www.apc.com. APC's obligation under this warranty is limited to repairing or replacing, at its own sole option, any such defective products. Repair or replacement of a defective Product or part thereof does not extend the original warranty period.

This warranty applies only to the original purchaser who must have properly registered the Product within 10 days of purchase. Products may be registered online at warranty.apc.com.

APC shall not be liable under this warranty if its testing and examination disclose that the alleged defect in the Product does not exist or that it was caused by end user's or any third person's misuse, negligence, improper installation, testing, operation or use of the Product contrary to APC's recommendations or specifications. Further, APC shall not be liable for defects resulting from: 1) unauthorized attempts to repair or modify the Product, 2) incorrect or inadequate electrical voltage or connection, 3) inappropriate on-site operation conditions, 4) Acts of God, 5) exposure to the elements, or 6) theft. In no event shall APC have any liability under this warranty for any Product where the serial number has been altered, defaced, or removed.

EXCEPT AS SET FORTH ABOVE, THERE ARE NO WARRANTIES, EXPRESS OR IMPLIED, BY OPERATION OF LAW OR OTHERWISE, APPLICABLE TO PRODUCTS SOLD, SERVICED OR FURNISHED UNDER THIS AGREEMENT OR IN CONNECTION HEREWITH.

APC DISCLAIMS ALL IMPLIED WARRANTIES OF MERCHANTABILITY, SATISFACTION AND FITNESS FOR A PARTICULAR PURPOSE.

APC EXPRESS WARRANTIES WILL NOT BE ENLARGED, DIMINISHED, OR AFFECTED BY AND NO OBLIGATION OR LIABILITY WILL ARISE OUT OF, APC'S RENDERING OF TECHNICAL OR OTHER ADVICE OR SERVICE IN CONNECTION WITH THE PRODUCTS.

THE FOREGOING WARRANTIES AND REMEDIES ARE EXCLUSIVE AND IN LIEU OF ALL OTHER WARRANTIES AND REMEDIES. THE WARRANTIES SET FORTH ABOVE CONSTITUTE APC'S SOLE LIABILITY AND PURCHASER'S EXCLUSIVE REMEDY FOR ANY BREACH OF SUCH WARRANTIES. APC'S WARRANTIES RUN ONLY TO ORIGINAL PURCHASER AND ARE NOT EXTENDED TO ANY THIRD PARTIES.

IN NO EVENT SHALL APC, ITS OFFICERS, DIRECTORS, AFFILIATES OR EMPLOYEES BE LIABLE FOR ANY FORM OF INDIRECT, SPECIAL, CONSEQUENTIAL OR PUNITIVE DAMAGES, ARISING OUT OF THE USE, SERVICE OR INSTALLATION, OF THE PRODUCTS, WHETHER SUCH DAMAGES ARISE IN CONTRACT OR TORT, IRRESPECTIVE OF FAULT, NEGLIGENCE OR STRICT LIABILITY OR WHETHER APC HAS BEEN ADVISED IN ADVANCE OF THE POSSIBILITY OF SUCH DAMAGES. SPECIFICALLY, APC IS NOT LIABLE FOR ANY COSTS, SUCH AS LOST PROFITS OR REVENUE (WHETHER DIRECT OR INDIRECT), LOSS OF EQUIPMENT, LOSS OF USE OF EQUIPMENT, LOSS OF SOFTWARE, LOSS OF DATA, COSTS OF SUBSTITUANTS, CLAIMS BY THIRD PARTIES, OR OTHERWISE.

NO SALESMAN, EMPLOYEE OR AGENT OF APC IS AUTHORIZED TO ADD TO OR VARY THE TERMS OF THIS WARRANTY.

NOTHING IN THIS LIMITED WARRANTY SHALL SEEK TO EXCLUDE OR LIMIT APC'S LIABILITY FOR DEATH OR PERSONAL INJURY RESULTING FROM ITS NEGLIGENCE OR ITS FRAUDULENT MISREPRESENTATION OR TO THE EXTENT THAT IT CANNOT BE EXCLUDED OR LIMITED BY APPLICABLE LAW.

To obtain service under warranty you must obtain a Returned Material Authorization (RMA) number from customer support. Customers with warranty claims issues may access the APC worldwide customer support network through the APC Web site: support.apc.com. Select your country from the country selection pull-down menu. Open the Support tab at the top of the web page to obtain contact information for customer support in your region. Products must be returned with transportation charges prepaid and must be accompanied by a brief description of the problem encountered and proof of date and place of purchase.

APC Worldwide Customer Support

Customer support for this or any other APC product is available at no charge in any of the following ways:

- Visit the APC Web site to access documents in the APC Knowledge Base and to submit customer support requests.
 - **www.apc.com** (Corporate Headquarters)
Connect to localized APC Web sites for specific countries, each of which provides customer support information.
 - **www.apc.com/support/**
Global support searching APC Knowledge Base and using e-support.
- Contact the APC Customer Support Center by telephone or e-mail.
 - Local, country-specific centers: go to **www.apc.com/support/contact** for contact information.

For information on how to obtain local customer support, contact the APC representative or other distributors from whom you purchased your APC product.

© 2011 APC by Schneider Electric. APC, the APC logo, Smart-UPS and PowerChute are owned by Schneider Electric Industries S.A.S., American Power Conversion Corporation, or their affiliated companies. All other trademarks are property of their respective owners.